

J package

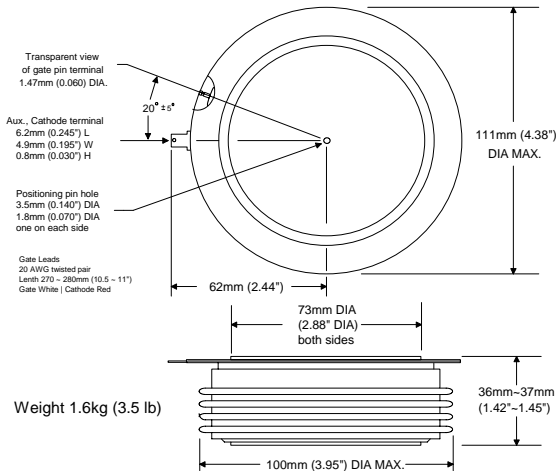

Part number scheme

J T 17 N 45 KNX
 1 2 3 4 5 6

- 1) Package designation
- 2) Thyristor designation (i.e. SCR)
- 3) Series number
- 4) Designates standard recovery time
- 5) Voltage Multiplier (example: 45 x 100 = 4500)
- 6) Proprietary suffix

Features:

- ✓ All diffused silicone.
- ✓ Center amplifying gate.
- ✓ Standard recovery time for phase control applications.
- ✓ Disk press package (nick named, Hockey Puck)
- ✓ Metal and ceramic package construction.
- ✓ Double side cooling.

Voltage

Parameter	Symbol	Rating	Units
Maximum Repetitive Off-State Voltage <small>Notes: 1, 3, 4, 5, 6, 7</small>	V_{DRM}	3500 ~ 4500	Volts
Maximum Repetitive Reverse Voltage <small>Notes: 1, 3, 4, 5, 6</small>	V_{RRM}	3500 ~ 4500	Volts
Maximum non repetitive Surge of Reverse Voltage <small>Notes: 2, 3, 4, 5, 6</small>	V_{RSM}	$V_{RRM} + 100$	Volts
Critical rate of rising off-state Voltage, Linear to 80% of V_{DRM} <small>Note: 2</small>	dv/dt	500	$V/\mu s$
<small>Note 1: T_J 25°C. Note 2: T_J 125°C. Note 3: Measured at the peak of the sine wave, Note 4: Below 0°C derate V_{DRM} and V_{RRM} 10%. Note 5: V_{DRM} and V_{RRM} have I_{DRM}, I_{RRM} of up to 50mA. Note 6: V_{DR} and V_{RR} have typical I_{DR}, I_{RR} of 3~7mA. Note 7: For DC applications derate V_{DRM} 45%.</small>			
Specifying voltage:	4000V, JT17N40		
3500V, JT17N35	4500V, JT17N45	Above 4500V inquire for availability.	

Gate

Parameter	Symbol	Rating			Units
		Temp.	Typ.	Max.	
Gate Trigger Voltage <small>Note 3</small>	V_{GT}	-20°C	2.3 ~ 2.8	3	Volts
		25°C	1.9 ~ 2.4		
		125°C	1.4 ~ 1.6		
Maximum Gate Trigger Current <small>Notes 1,3</small>	I_{GT}		300		mA
Minimum anode cathode Current to Latch on-state <small>Notes 1, 5</small>	I_L		400		mA
Maximum permissible Gate Voltage not to Trigger <small>Notes 1,3</small>	V_{GDM}		250		mV
Maximum permissible Gate Current not to Trigger <small>Notes 1, 3</small>	I_{GDM}		10		mA
Maximum peak non repetitive Gate Voltage <small>Notes 2, 3</small>	V_{GM}		8.4		Volts
Maximum Negative Gate Voltage <small>Notes 2, 4</small>	$-V_{GM}$		5		Volts
Maximum non repetitive Gate Current <small>Notes 2, 3</small>	I_{GM}		3.7		Amperes
Maximum Repetitive Gate Current <small>Notes 2, 3</small>	I_{GRM}		1		Amperes
Average Gate Power (recommended) <small>Note 2, 3</small>	$P_{G(AVE)}$		0.9 ~ 3		Watts
<small>Note 1: T_J 25°C. Note 2: T_J 125°C. Note 3: Rectangular pulse, $t_p \leq 8.3$ ms. Note 4: Rectangular $-V_{DC}$ pulse, $t_p \leq 8.3$ ms. Note 5: Test conditions: I_{DC} $R_L = 12\Omega$.</small>					

Gate Characteristics

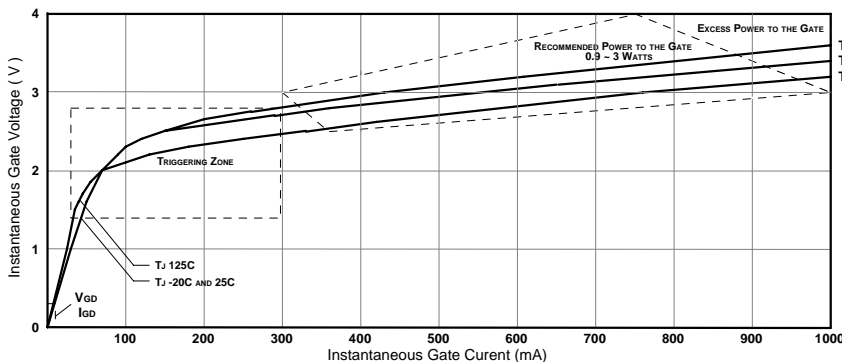

This graph depicts a typical device, each device has unique characteristics

Maximum non repetitive GATE POWER (PGM)

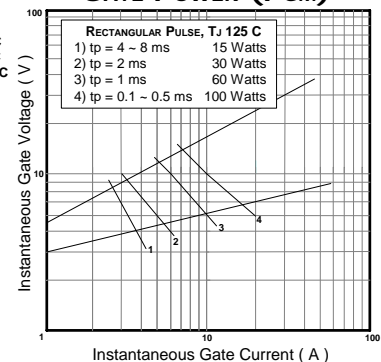

Amperage

Parameter	Symbol	Rating	Units
Maximum, Average, On state, Current <small>Notes: 3, 4</small>	$I_{T(AVE)}$	1650	Amperes
Maximum, RMS, On state, Current <small>Notes: 3, 4</small>	$I_{T(RMS)}$	2300	Amperes
Maximum non repetitive, Surge, On state, Current, with no reverse voltage reapplied. <small>Notes: 2, 4</small>	$I_{TSM} 0\% V_{RRM}$	Consult factory	kA
Critical rate of rising On-state Current, non repetitive <small>Note: 6, 7</small>	di/dt	1,200	A/ μ s
Critical rate of rising On-state Current <small>Note: 6, 7</small>	di/dt	500	A/ μ s
Holding Current <small>Notes: 1, 5</small>	I_H	250	mA
I_{DR} = Repetitive, Off-State, leakage Current (typical) <small>Note: 1</small> I_{RR} = Repetitive, Reverse, leakage Current. (typical) <small>Note: 1</small>	I_{DR} & I_{RR}	3 ~ 7	mA
I_{DRM} = Maximum (threshold), Repetitive, Off-State, Current. <small>Note: 1</small> I_{RRM} = Maximum (threshold), Repetitive, Reverse, Current. <small>Note: 1</small>	I_{DRM} & I_{RRM}	50	mA
Fuse's absolute maximum $I^2 t$ with no reverse voltage reapplied <small>Note: 2, 4</small>	$I^2 t, 0\% V_{RR}$	Consult factory	kA
Fuse's absolute maximum $I^2 t$ with up to 80% of V_{RRM} reapplied <small>Note: 2, 4</small>	$I^2 t, \leq 80\% V_{RRM}$	Consult factory	kA
Reverse Recovery Charge (C_S = Stored Charge)	Q_{RR}	Consult factory	μC_s
<small>Note 1: T_J 25°C. Note 2: T_J 125°C. Note 3: T_{Case} 55°C, double side air cooled. Note 4: 180° conduction, 60Hz sine wave.</small> <small>Note 5: Test conditions: I_{DC} $R_L = 12\Omega$. Note 6: Switching from $V_{DRM} \leq 1000V$ Note 7: In addition to 0.2μF and 20Ω snubber circuit</small>			

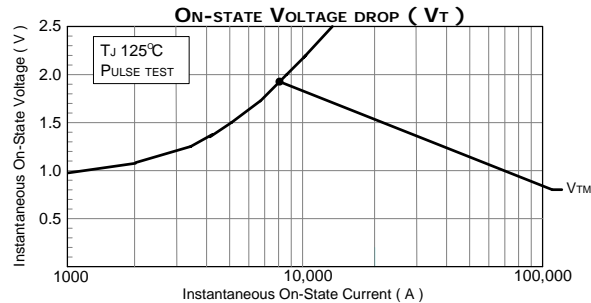

These graphs depict a typical device, each device has unique characteristics

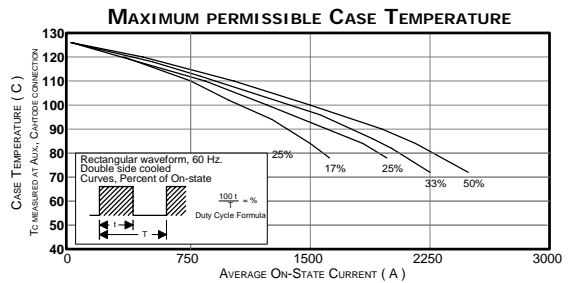
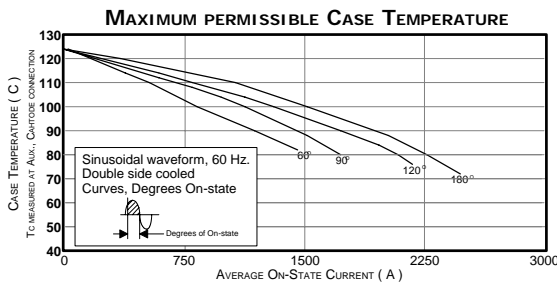
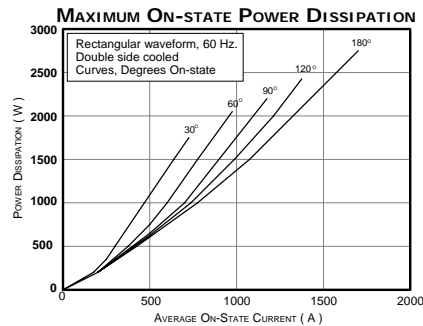
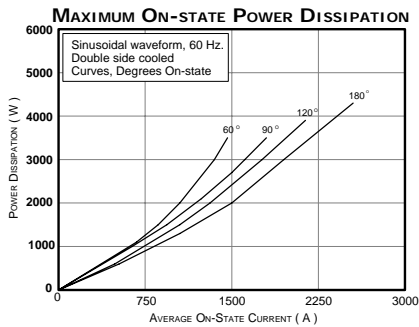

Thermal & Mechanical

Parameter	Symbol	Rating	Units
Operating Temperature Range	T_J	-40° ~ 125°	°Celsius
Maximum Thermal resistance, Junction to Case <small>Notes: 1, 3, 5</small>	R_{th-J-C}	0.012	°C/W
Maximum Thermal resistance, Case to Heat Sink <small>Notes: 1, 2, 3, 4, 5</small>	$R_{th-C-hs}$	0.002	°C/W
Mounting Pressure		3600 ~ 4500 8000 ~ 10000	kg lb.
<small>Note 1: Recommended mounting pressure applied Note 2: Mounting surfaces flat and greased Note 3: Double side cooled</small> <small>Note 4: Case Temperature measured at aux., cathode Note 5: 180° on-state</small>			